



<p>Size 10 to 30 up to 315 bar up to 600 L/min</p>	<p>Pressure Relief Valve Pilot Operated Type RB, RBE, Series 10</p>	<p>Data Sheet R-1002/10.98 GB</p>
<p>Features</p> <ul style="list-style-type: none"> ◇ Accurate movement, quick response and stability. ◇ Minimised flow pass resistance. ◇ Relatively small pressure override. ◇ Unloads smoothly without shocks if used with a non shock valve. ◇ For sub-plate mounting, porting pattern to DIN 24 340 Form E, ISO 6264 and CETOP-RP 121 H. Sub-plates must be ordered separately. ◇ Suitable for installation in manifolds. ◇ Three adjustment elements: rotary knob; sleeve with hexagon and protective cap; lockable rotary knob with scale and rotary knob with scale. ◇ Two pressure ratings. ◇ Solenoid operated unloading via a built-on directional spool valve. <p>Functional Description</p> <p>Type RB and RBE Series 10 Pressure Relief Valves are balance piston, seat type, relief valves that are used:</p> <ul style="list-style-type: none"> ◇ To control the maximum pressure within a hydraulic circuit thus preventing overload of hydraulic circuit, hydraulic unit, pumps, etc. ◇ To control pressure within a hydraulic unit, e.g. load/unload hydraulic circuit pressure. <div style="text-align: right; margin-top: 20px;">  <p>Type RBE</p> </div>		
<p>Model RB, RBE</p>	<p>Page 1.9</p>	<p>Data Sheet R-1002/10.98</p>
		

Pressure Relief Valve Type RB

Type RB pressure relief valves primarily comprise a main valve (1) with main spool cartridge (3) and a pilot valve (2) with pressure adjustment element.

The pressure present in channel A acts on the main poppet (3). At the same time, pressure is present at the control lines (6) and (7) with orifices (4) and (5) on the spring loaded side of the main poppet (3) and at the poppet (8) in the pilot valve (2).

If the pressure in channel A rises above the value set at spring (9), poppet (8) opens against spring (9). The signal for this action occurs internally via control lines (11) and (6) from channel A.

The pressure fluid on the spring loaded side of main poppet (3) now flows via control line (7), orifice bore (5) and ball (8) into the spring chamber (12).

Note: In type RB..-10/..-... the pressure fluid flows internally via control line (13) to the tank.
In type RB..10/..Y.. the pressure fluid flows externally via control line.

Because of orifices (4) and (5), a pressure drop happens at the main poppet (3), the connection from channel A to channel B is open. The pressure fluid now flows from channel A to channel B whilst maintaining the set operating pressure.

The pressure relief valve can be unloaded or switched over to a different pressure (second pressure stage) via Port X (15).

Pressure Relief Valve Type RBE

Type RBE pressure relief valves are principally the same as type RB pressure relief valves with the exception that the unloading at the main poppet (3) is reached through the control of the mounted directional valve (16).

Pressure Relief with Pressure Shock Damping (Sandwich Plate)

With a pressure shock damping valve (17) the flow from B2 to B1 is controlled, thus avoiding the pressure peaks and acoustic unloading shocks in the return line. It is installed between the pilot valve (2) and the directional valve (16).

The degree of the damping (unloading shock) is determined by the spring setting (19).

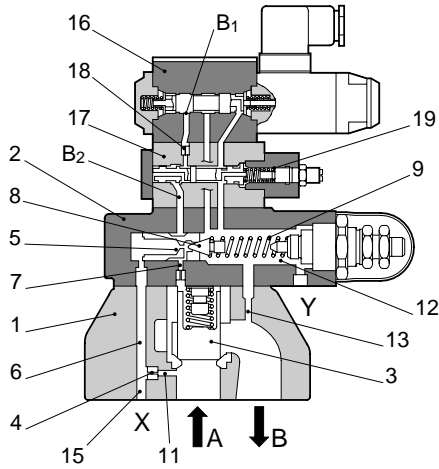

Model RB, RBE

Page 2.9

Data Sheet R-1002/10.98

Ordering Code – Pressure Relief Valve, Pilot Operated

RB 10 P 10 1 / 315 X Y V

Pressure Relief Valve, Pilot Operated

Size

Size	RB*P	RB*C
10	O	O
20	O	-
30	O	O

Type of Mounting

P: Sub-plate Mounting

Series Number

10

Setting Element

- 1: Rotary Knob
- 2: Thread Pin with Hexagon and Protective Cap
- 3: Lockable Rotary Knob

Suitable Oil

No Code: Mineral Oil
 V: Phosphate Ester
 W: Fatty Acid Ester, Water Glycol

Drain Line

No Code: Internally Drained
 Y: Externally Drained

Vent Port

No Code: Without Vent Port
 X: With Vent Port

Maximum Setting Pressure

100: 100 bar
 315: 315 bar

Ordering Code – Pilot Relief Valve, Direct Operated for RB10, 20 & 30

RB10X 10 1 / 315 Y V

Pilot Relief Valve, Direct Operated for RB10, 20 & 30

Series Number

10

Adjusting Element

- 1: Rotary Knob
- 2: Thread Pin with Hexagon and Protective Cap
- 3: Lockable Rotary Knob

Suitable Oil

No Code: Mineral Oil
 V: Phosphate Ester
 W: Fatty Acid Ester, Water Glycol

Drain Line

No Code: Internally Drained
 Y: Externally Drained

Maximum Setting Pressure

100: 100 bar
 315: 315 bar



Model
RB, RBE

Page
3.9

Data Sheet
R-1002/10.98

Ordering Code – Pressure Relief Valve, Pilot Operated with Mounted Directional Valve

RBE 10 P 10 B 1 / 315 X Y W D 24 CL S V

Pressure Relief Valve, Pilot Operated with Mounted Directional Valve

Size

Size	RBE**P	RBE**C
10	O	O
20	O	-
30	O	O

Type of Mounting

P: Sub-plate Mounting
C: Cartridge Type

Series Number

10

Vent Function

A: Normally closed
B: Normally open

Setting Element

- 1: Rotary Knob
- 2: Thread Pin with Hexagon and Protective Cap
- 3: Lockable Rotary Knob

Maximum Setting Pressure

100: 100 bar 315: 315 bar

Vent Port

No Code: Without vent port (For Cartridge)
X: With vent port for Sub-plate Mounting Type

Drain Line

No Code: Internally Drained
Y: Externally Drained

Suitable Oil

No Code: Mineral Oil
V: Phosphate Ester
W: Fatty Acid Ester,
W1 Water Glycol

Pressure Shock Damping

No Without Pressure
Code: Shock Damping
S: With Pressure Shock Damping

Electric Connection Types

Code	Connection Type	Voltage		
		A	D	R
No Code	Lead wire (shur plug)	-	O	-
B	DIN angled plug	O	O	-
C	Din large angled plug	O	O	O
CL	Din large angled plug with light	O	O	-

Voltage

12: 12V 100: 100V
24: 24V 200: 200V

Electrical Sources

A: Alternating Current (AC)
D: Direct Current (DC)
R: AC/DC

Type of Solenoid

W: Wet Pin Type with manual override



Model
RB, RBE

Page
4.9

Data Sheet
R-1002/10.98

Ordering Code – Pilot Relief Valve, Direct Operated for RBE10, 20 and 30

RBE10X 10 B 1 / 315 Y W D 24 CL S V

**Pilot Relief Valve,
Direct Operated for
RBE10, 20 and 30**

Series Number
10

Vent Function

A: Normally closed
B: Normally open

Adjusting Element

- 1: Rotary Knob
- 2: Thread Pin with Hexagon and Protective Cap
- 3: Lockable Rotary Element

Maximum Setting Pressure

100: 100 bar
315: 315 bar

Drain Line

No Code: Internally Drained
Y: Externally Drained

Type of Solenoid

W: Wet Pin Type with manual override

Electrical Sources

A: Alternating Current (AC)
D: Direct Current (DC)
R: AC/DC

Suitable Oil

No Code: Mineral Oil
V: Phosphate Ester
W: Fatty Acid Ester,
W1 Water Glycol

Pressure Shock Damping

No Code: Without Pressure Shock Damping
S: With Pressure Shock Damping

Electric Connection Types

Code	Connection Type	Voltage		
		A	D	R
No Code	Lead wire (shur plug)	-	0	-
B	DIN angled plug	0	0	-
C	Din large angled plug	0	0	0
CL	Din large angled plug with light	0	0	-

Voltage

12: 12V 100: 100V
24: 24V 200: 200V

Model
RB, RBE

Page
5.9

Data Sheet
R-1002/10.98



Technical Data

For applications outside the following parameters, please consult Kawasaki Precision Machinery (UK) Ltd.

Nominal Size			10	20	30
Weight			RB10	RB20	RB30
Sub-plate	RB	kg	2.6	3.5	4.4
Sub-plate	RBE ¹	kg	3.8	4.7	5.6

¹ Pressure Relief Valve with Built-on Directional Spool Valve.

Hydraulic Data

Nominal Pressure	315 bar
Maximum Operating Pressure	315 bar at Ports A, B and X
Maximum Back Pressure	RB 315 bar, RBE 160 bar
Pressure Fluid	Mineral oil, phosphate ester, fatty acid ester and water glycol. Phosphate ester is only suitable for use with FPM seals.
Pressure Fluid Temperature Range	-20°C to +70°C
Viscosity Range	2.8 to 380cSt

Maximum Flow	RB10	RB20	RB30
Sub-plate mounting – L/min	200	400	600

Degree of Contamination Maximum permissible degree of contamination of fluid is to NAS 1638 Class 9. Kawasaki recommend a filter with a minimum retention rate of $\beta_{10} \geq 75$.

Settable Pressure Minimum - Flow dependent – see [Characteristic Curves](#)
Maximum - 100 and 315 bar

Electrical Data

	DC	AC
Voltage		
Nominal voltage	12, 24V	100, 200, 110, 220 V, 50/60Hz
Voltage tolerance	±10%	
Nominal Power	26 W	58VA (holding) 182VA (switching)
Protection	IP65	
Permissible switching frequency	15000 1/h	7200 1/h
Connection type	Plug Connector (single connection)	



Model
RB, RBE

Page
6.9

Data Sheet
R-1002/10.98

Characteristic Curves

Measure at $\nu = 36\text{cSt}$ and $t = 50^\circ\text{C}$

The Characteristic Curves were measured with external, zero pressure pilot oil drain. With internal pilot oil drain pressure, the inlet pressure increases by the outlet pressure present at port B.

Input Pressure/Flow

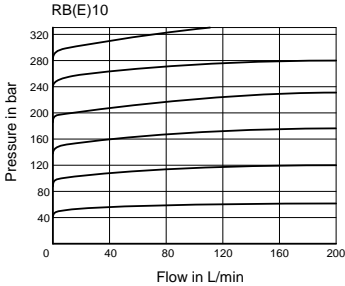

By Pass Pressure/Flow

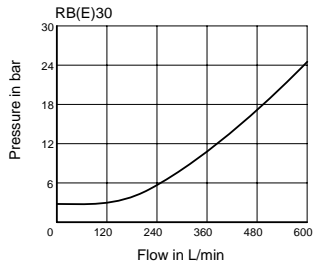
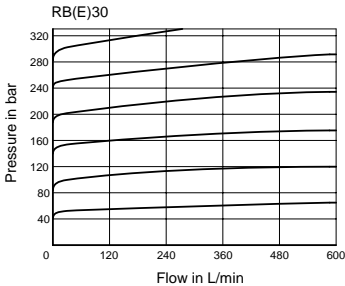
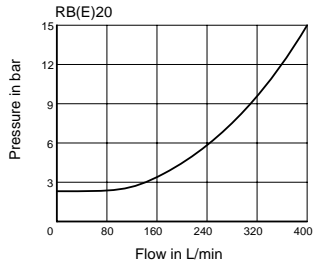
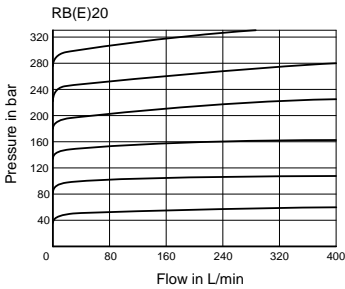
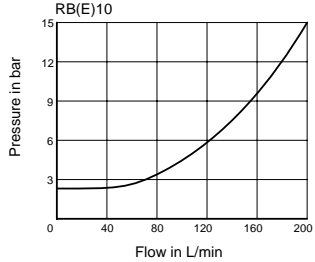

Model
RB, RBE

Page
7.9

Data Sheet
R-1002/10.98

Unit Dimensions – for Sub-plate Mounting

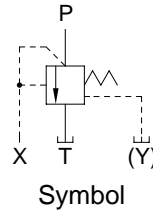
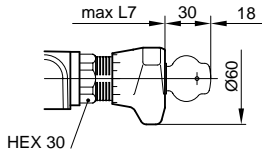
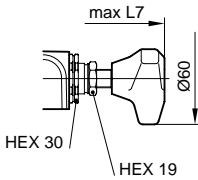
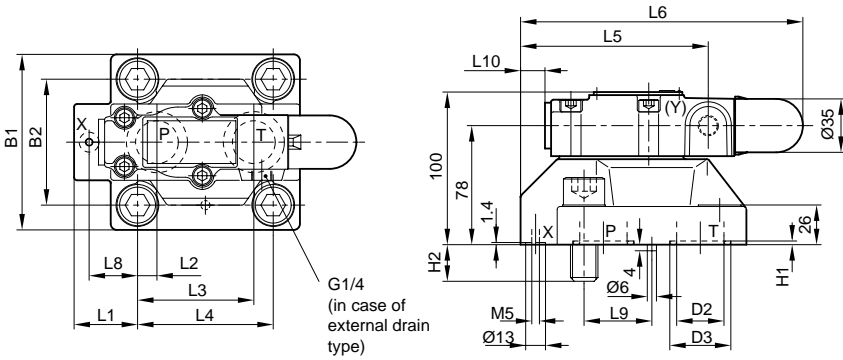

Model RB, RBE

Page 8.9

Data Sheet R-1002/10.98



Unit Dimensions (continued)

Type	B1	B2	D1	D2	D3	L1	L2	L3	L4	L5	L6
RB10	78	54	M12	12	20	23.5	22.2	47.6	54	99.5	156.5
RB20	100	69.8	M16	25	35	34	11.1	55.6	66.7	112.7	169.7
RB30	115	82.5	M18	31	40	41.5	12.7	76.2	89	122.9	179.9

Type	L7	L8	L9	L10	H1	H2	O-RING JIS B2401		Weight
							P,T Port	X Port	
RB10	179.5	0	22.1	-7.5	1.8	19	P16, H _s 90	P10, H _s 90	2.6 kg
RB20	193	23.8	33.3	5.7	2.4	24	G30, H _s 90	P10, H _s 90	3.5 kg
RB30	203	31.7	44.4	15.9	2.4	24	G35, H _s 90	P10, H _s 90	4.4 kg

Valve Fixing Screws for:

Type RB/RBE 10 4 off M12 x 45
 DIN 912-10.9
 $M_A = 98 \text{ Nm}$

Type RB/DBE 20 4 off M16 x 50
 DIN 912-10.9
 $M_A = 235 \text{ Nm}$

Type RB/RBE 30 4 off M18 x 50
 DIN 912-10.9
 $M_A = 333 \text{ Nm}$

KAWASAKI PRECISION MACHINERY (UK) LTD
 Ernesettle, Plymouth, Devon, PL5 2SA, England
 Tel: +44 1752 364394 Fax: +44 1752 364816
 E Mail: info@kpm-uk.co.uk

The specified data is for product description purposes only and may not be deemed to be guaranteed unless expressly confirmed in the contract

ALL RIGHTS RESERVED, SUBJECT TO REVISION

Model
 RB, RBE

Page
 9.9

Data Sheet
 R-1002/10.98

